



Bridgelux® Gen 7 V18 Array

Product Data Sheet DS102



BXRE-27x4000

30x4000

35x4000

40x4000

50x4001

57x4001

65x4001

Introduction

V Series



The V Series™ LED Array products deliver high quality light in a compact and cost-effective solid-state lighting package. These Chip-on-Board (CoB) arrays can be efficiently driven at twice the nominal drive current, enabling design flexibility not previously possible. This high flux density light source is designed to support a wide range of high quality, low cost directional luminaires and replacement lamps for commercial and residential applications.

The V18 LED Array is available in a variety of electrical, CCT and CRI combinations providing substantial design flexibility and energy efficiencies.

Lighting system designs incorporating these LED Arrays deliver increased system level efficacy and longer service life. Typical applications include, but are not limited to, replacement lamps, task, accent, spot, track, down light, wide area, security, and wall pack.

Features

- Efficacy of 155 lm/W typical
- Compact high flux density light source
- Uniform high quality illumination
- Minimum 70, 80 and 90 CRI options
- Streamlined thermal path
- ENERGY STAR® / ANSI compliant color binning structure with 3 SDCM and 4 SDCM options
- More energy efficient than incandescent, halogen and fluorescent lamps
- Low voltage DC operation
- Instant light with unlimited dimming

Benefits

- Enhanced optical control
- Clean white light without pixilation
- High quality true color reproduction
- Significantly reduced thermal resistance and increased operating temperatures
- Uniform consistent white light
- Lower operating costs
- Easy to use with daylight and motion detectors to enable increased energy savings
- Reduced maintenance costs
- Environmentally friendly, no disposal issue



Contents

Product Feature Map	2
Product Nomenclature	2
Product Selection Guide	3
Performance at Commonly Used Drive Currents	5
Electrical Characteristics	9
Absolute Maximum Ratings	10
Performance Curves	11
Typical Radiation Pattern	15
Typical Color Spectrum	16
Mechanical Dimensions	17
Color Binning Information	18
Packaging and Labeling	19
Design Resources	21
Precautions	21
Disclaimers	21
About Bridgelux	22

Product Selection Guide

The following product configurations are available:

Table 1: Selection Guide, Pulsed Measurement Data ($T_j = T_c = 25^\circ\text{C}$)

Part Number	Nominal CCT ¹ (K)	CRI ²	Nominal Drive Current ³ (mA)	Typical Pulsed Flux ^{4,5,6} $T_c = 25^\circ\text{C}$ (lm)	Minimum Pulsed Flux ^{6,7} $T_c = 25^\circ\text{C}$ (lm)	Typical V_f (V)	Typical Power (W)	Typical Efficacy (lm/W)
BXRE-27E4000-B-7X	2700	80	900	4644	4358	34.8	31.4	148
BXRE-27E4000-C-7X	2700	80	1170	6038	5555	34.8	40.8	148
BXRE-27G4000-B-7X	2700	90	900	3870	3632	34.8	31.4	123
BXRE-27G4000-C-7X	2700	90	1170	5032	4629	34.8	40.8	123
BXRE-30E4000-B-7X	3000	80	900	4860	4540	34.8	31.4	155
BXRE-30E4000-C-7X	3000	80	1170	6318	5787	34.8	40.8	155
BXRE-30G4000-B-7X	3000	90	900	4015	3723	34.8	31.4	128
BXRE-30G4000-C-7X	3000	90	1170	5221	4803	34.8	40.8	128
BXRE-35E4000-B-7X	3500	80	900	4983	4676	34.8	31.4	159
BXRE-35E4000-C-7X	3500	80	1170	6479	5960	34.8	40.8	159
BXRE-35G4000-B-7X	3500	90	900	4160	3904	34.8	31.4	133
BXRE-35G4000-C-7X	3500	90	1170	5409	4977	34.8	40.8	133
BXRE-40E4000-B-7X	4000	80	900	5031	4722	34.8	31.4	160
BXRE-40E4000-C-7X	4000	80	1170	6541	6018	34.8	40.8	160
BXRE-40G4000-B-7X	4000	90	900	4305	4041	34.8	31.4	137
BXRE-40G4000-C-7X	4000	90	1170	5598	5150	34.8	40.8	137
BXRE-50C4001-B-74	5000	70	900	5515	5176	34.8	31.4	176
BXRE-50C4001-C-74	5000	70	1170	7170	6597	34.8	40.8	176
BXRE-50E4001-B-74	5000	80	900	5184	4865	34.8	31.4	165
BXRE-50E4001-C-74	5000	80	1170	6740	6201	34.8	40.8	165
BXRE-50G4001-B-74	5000	90	900	4412	4140	34.8	31.4	141
BXRE-50G4001-C-74	5000	90	1170	5736	5277	34.8	40.8	141
BXRE-57C4001-B-74	5700	70	900	5321	4994	34.8	31.4	170
BXRE-57C4001-C-74	5700	70	1170	6919	6365	34.8	40.8	170
BXRE-57E4001-B-74	5700	80	900	5273	4949	34.8	31.4	168
BXRE-57E4001-C-74	5700	80	1170	6856	6308	34.8	40.8	168
BXRE-65C4001-B-74	6500	70	900	5418	5085	34.8	31.4	173
BXRE-65C4001-C-74	6500	70	1170	7045	6481	34.8	40.8	173
BXRE-65E4001-B-74	6500	80	900	5370	5039	34.8	31.4	171
BXRE-65E4001-C-74	6500	80	1170	6982	6423	34.8	40.8	171

Notes for Tables 1:

1. Nominal CCT as defined by ANSI C78.377-2011. Products with CCTs 5000K-6500K are hot targeted to 85°C .
2. CRI values are minimums. Minimum Rg value for 80 CRI products is 0, the minimum Rg values for 90 CRI products is 50.
3. Drive current is referred to as nominal drive current.
4. Products tested under pulsed condition (10ms pulse width) at nominal test current where T_j (junction temperature) = T_c (case temperature) = 25°C .
5. Typical performance values are provided as a reference only and are not a guarantee of performance.
6. Bridgelux maintains a $\pm 7\%$ tolerance on flux measurements.
7. Minimum flux values at the nominal test current are guaranteed by 100% test.

Product Selection Guide

Table 2: Selection Guide, Stabilized DC Performance ($T_c = 85^\circ\text{C}$)^{4,5}

Part Number	Nominal CCT ¹ (K)	CRI ²	Nominal Drive Current ³ (mA)	Typical DC Flux ^{4,5} $T_c = 85^\circ\text{C}$ (lm)	Minimum DC Flux ⁶ $T_c = 85^\circ\text{C}$ (lm)	Typical V_f (V)	Typical Power (W)	Typical Efficacy (lm/W)
BXRE-27E4000-B-7X	2700	80	900	4180	3923	34.0	30.6	137
BXRE-27E4000-C-7X	2700	80	1170	5434	5000	34.0	39.8	137
BXRE-27G4000-B-7X	2700	90	900	3483	3269	34.0	30.6	114
BXRE-27G4000-C-7X	2700	90	1170	4529	4166	34.0	39.8	114
BXRE-30E4000-B-7X	3000	80	900	4374	4086	34.0	30.6	143
BXRE-30E4000-C-7X	3000	80	1170	5686	5208	34.0	39.8	143
BXRE-30G4000-B-7X	3000	90	900	3614	3351	34.0	30.6	118
BXRE-30G4000-C-7X	3000	90	1170	4699	4323	34.0	39.8	118
BXRE-35E4000-B-7X	3500	80	900	4484	4208	34.0	30.6	147
BXRE-35E4000-C-7X	3500	80	1170	5831	5364	34.0	39.8	147
BXRE-35G4000-B-7X	3500	90	900	3744	3514	34.0	30.6	122
BXRE-35G4000-C-7X	3500	90	1170	4868	4479	34.0	39.8	122
BXRE-40E4000-B-7X	4000	80	900	4528	4250	34.0	30.6	148
BXRE-40E4000-C-7X	4000	80	1170	5887	5416	34.0	39.8	148
BXRE-40G4000-B-7X	4000	90	900	3875	3637	34.0	30.6	127
BXRE-40G4000-C-7X	4000	90	1170	5038	4635	34.0	39.8	127
BXRE-50C4001-B-74	5000	70	900	4963	4658	34.0	30.6	162
BXRE-50C4001-C-74	5000	70	1170	6453	5937	34.0	39.8	162
BXRE-50E4001-B-74	5000	80	900	4666	4379	34.0	30.6	153
BXRE-50E4001-C-74	5000	80	1170	6066	5581	34.0	39.8	153
BXRE-50G4001-B-74	5000	90	900	3971	3726	34.0	30.6	130
BXRE-50G4001-C-74	5000	90	1170	5163	4750	34.0	39.8	130
BXRE-57C4001-B-74	5700	70	900	4789	4495	34.0	30.6	157
BXRE-57C4001-C-74	5700	70	1170	6227	5729	34.0	39.8	157
BXRE-57E4001-B-74	5700	80	900	4746	4454	34.0	30.6	155
BXRE-57E4001-C-74	5700	80	1170	6170	5677	34.0	39.8	155
BXRE-65C4001-B-74	6500	70	900	4876	4576	34.0	30.6	159
BXRE-65C4001-C-74	6500	70	1170	6340	5833	34.0	39.8	159
BXRE-65E4001-B-74	6500	80	900	4833	4535	34.0	30.6	158
BXRE-65E4001-C-74	6500	80	1170	6284	5781	34.0	39.8	158

Notes for Tables 2:

- Nominal CCT as defined by ANSI C78.377-2011. Products with a CCT of 5000K-6500K are hot targeted to 85°C.
- CRI values are minimums. Minimum Rg value for 80 CRI products is 0, the minimum Rg values for 90 CRI products is 50.
- Drive current is referred to as nominal drive current.
- Typical stabilized DC performance values are provided as reference only and are not a guarantee of performance.
- Typical performance is estimated based on operation under DC (direct current) with LED array mounted onto a heat sink with thermal interface material and the case temperature maintained at 85°C. Based on Bridgelux test setup, values may vary depending on the thermal design of the luminaire and/or the exposed environment to which the product is subjected.
- Minimum flux values at elevated temperatures are provided for reference only and are not guaranteed by 100% production testing. Based on Bridgelux test setup, values may vary depending on the thermal design of the luminaire and/or the exposed environment to which the product is subjected.

Performance at Commonly Used Drive Currents

V Series LED arrays are tested to the specifications shown using the nominal drive currents in Table 1. V Series may also be driven at other drive currents dependent on specific application design requirements. The performance at any drive current can be derived from the current vs. voltage characteristics shown in Figures 1 & 2 and the flux vs. current characteristics shown in Figures 3 & 4. The performance at commonly used drive currents is summarized in Table 3.

Table 3: Product Performance at Commonly Used Drive Currents

Part Number	CRI	Drive Current ¹ (mA)	Typical V _f T _c = 25°C (V)	Typical Power T _c = 25°C (W)	Typical Flux ² T _c = 25°C (lm)	Typical DC Flux ³ T _c = 85°C (lm)	Typical Efficacy T _c = 25°C (lm/W)
BXRE-27E4000-B-7X	80	450	33.2	14.9	2456	2250	164
		600	33.8	20.3	3219	2943	159
		900	34.8	31.4	4644	4180	148
		1350	36.3	49.0	6719	6095	137
		1800	37.5	67.5	8569	7736	127
BXRE-27E4000-C-7X	80	585	33.2	19.4	3110	2740	160
		780	33.8	26.3	4073	3569	155
		1170	34.8	40.8	6038	5434	148
		1755	36.2	63.6	8477	7234	133
		2340	37.5	87.6	10788	9048	123
BXRE-27G4000-B-7X	90	450	33.2	14.9	2047	1875	137
		600	33.8	20.3	2682	2452	132
		900	34.8	31.4	3870	3483	123
		1350	36.3	49.0	5599	5079	114
		1800	37.5	67.5	7141	6446	106
BXRE-27G4000-C-7X	90	585	33.2	19.4	2592	2283	133
		780	33.8	26.3	3395	2974	129
		1170	34.8	40.8	5032	4529	123
		1755	36.2	63.6	7064	6029	111
		2340	37.5	87.6	8990	7540	103
BXRE-30E4000-B-7X	80	450	33.2	14.9	2570	2355	172
		600	33.8	20.3	3369	3080	166
		900	34.8	31.4	4860	4374	155
		1350	36.3	49.0	7032	6379	144
		1800	37.5	67.5	8968	8096	133
BXRE-30E4000-C-7X	80	585	33.2	19.4	3254	2867	168
		780	33.8	26.3	4262	3735	162
		1170	34.8	40.8	6318	5686	155
		1755	36.2	63.6	8870	7570	139
		2340	37.5	87.6	11288	9467	129

Notes for Table 3:

1. Alternate drive currents in Table 3 are provided for reference only and are not a guarantee of performance.
2. Bridgelux maintains a ± 7% tolerance on flux measurements.
3. Typical stabilized DC performance values are provided as reference only and are not a guarantee of performance.

Performance at Commonly Used Drive Currents

Table 3: Product Performance at Commonly Used Drive Currents (Continued)

Part Number	CRI	Drive Current ¹ (mA)	Typical V_f $T_c = 25^\circ\text{C}$ (V)	Typical Power $T_c = 25^\circ\text{C}$ (W)	Typical Flux ² $T_c = 25^\circ\text{C}$ (lm)	Typical DC Flux ³ $T_c = 85^\circ\text{C}$ (lm)	Typical Efficacy $T_c = 25^\circ\text{C}$ (lm/W)
BXRE-30G4000-B-7X	90	450	33.2	14.9	2123	1945	142
		600	33.8	20.3	2783	2544	137
		900	34.8	31.4	4015	3614	128
		1350	36.3	49.0	5809	5270	119
		1800	37.5	67.5	7408	6688	110
BXRE-30G4000-C-7X	90	585	33.2	19.4	2689	2369	138
		780	33.8	26.3	3522	3086	134
		1170	34.8	40.8	5221	4699	128
		1755	36.2	63.6	7329	6255	115
		2340	37.5	87.6	9327	7823	106
BXRE-35E4000-B-7X	80	450	33.2	14.9	2635	2414	176
		600	33.8	20.3	3453	3158	170
		900	34.8	31.4	4983	4484	159
		1350	36.3	49.0	7209	6540	147
		1800	37.5	67.5	9194	8300	136
BXRE-35E4000-C-7X	80	585	33.2	19.4	3337	2940	172
		780	33.8	26.3	4370	3830	166
		1170	34.8	40.8	6479	5831	159
		1755	36.2	63.6	9095	7762	143
		2340	37.5	87.6	11574	9708	132
BXRE-35G4000-B-7X	90	450	33.2	14.9	2200	2015	147
		600	33.8	20.3	2883	2636	142
		900	34.8	31.4	4160	3744	133
		1350	36.3	49.0	6019	5460	123
		1800	37.5	67.5	7676	6930	114
BXRE-35G4000-C-7X	90	585	33.2	19.4	2786	2454	143
		780	33.8	26.3	3649	3198	139
		1170	34.8	40.8	5409	4868	133
		1755	36.2	63.6	7594	6481	119
		2340	37.5	87.6	9664	8105	110
BXRE-40E4000-B-7X	80	450	33.2	14.9	2661	2437	178
		600	33.8	20.3	3487	3188	172
		900	34.8	31.4	5031	4528	160
		1350	36.3	49.0	7279	6603	149
		1800	37.5	67.5	9283	8380	138
BXRE-40E4000-C-7X	80	585	33.2	19.4	3369	2968	173
		780	33.8	26.3	4413	3867	168
		1170	34.8	40.8	6541	5887	160
		1755	36.2	63.6	9183	7837	144
		2340	37.5	87.6	11687	9802	133
BXRE-40G4000-B-7X	90	450	33.2	14.9	2277	2086	152
		600	33.8	20.3	2984	2728	147
		900	34.8	31.4	4305	3875	137
		1350	36.3	49.0	6229	5651	127
		1800	37.5	67.5	7944	7172	118

Notes for Table 3:

1. Alternate drive currents in Table 3 are provided for reference only and are not a guarantee of performance.
2. Bridgelux maintains a $\pm 7\%$ tolerance on flux measurements.
3. Typical stabilized DC performance values are provided as reference only and are not a guarantee of performance.

Performance at Commonly Used Drive Currents

Table 3: Product Performance at Commonly Used Drive Currents (Continued)

Part Number	CRI	Drive Current ¹ (mA)	Typical V _f T _c = 25°C (V)	Typical Power T _c = 25°C (W)	Typical Flux ² T _c = 25°C (lm)	Typical DC Flux ³ T _c = 85°C (lm)	Typical Efficacy T _c = 25°C (lm/W)
BXRE-40G4000-C-7X	90	585	33.2	19.4	2883	2540	148
		780	33.8	26.3	3776	3309	143
		1170	34.8	40.8	5598	5038	137
		1755	36.2	63.6	7858	6707	124
		2340	37.5	87.6	10001	8388	114
BXRE-50C4001-B-74	70	450	33.2	14.9	2917	2672	195
		600	33.8	20.3	3822	3495	189
		900	34.8	31.4	5515	4963	176
		1350	36.3	49.0	7979	7238	163
		1800	37.5	67.5	10175	9186	151
BXRE-50C4001-C-74	70	585	33.2	19.4	3693	3254	190
		780	33.8	26.3	4837	4239	184
		1170	34.8	40.8	7170	6453	176
		1755	36.2	63.6	10066	8591	158
		2340	37.5	87.6	12811	10744	146
BXRE-50E4001-B-74	80	450	33.2	14.9	2742	2511	183
		600	33.8	20.3	3593	3285	177
		900	34.8	31.4	5184	4666	165
		1350	36.3	49.0	7500	6804	153
		1800	37.5	67.5	9565	8635	142
BXRE-50E4001-C-74	80	585	33.2	19.4	3472	3058	179
		780	33.8	26.3	4547	3984	173
		1170	34.8	40.8	6740	6066	165
		1755	36.2	63.6	9462	8075	149
		2340	37.5	87.6	12042	10100	137
BXRE-50G4001-B-74	90	450	33.2	14.9	2333	2137	156
		600	33.8	20.3	3058	2796	151
		900	34.8	31.4	4412	3971	141
		1350	36.3	49.0	6383	5790	130
		1800	37.5	67.5	8140	7349	121
BXRE-50G4001-C-74	90	585	33.2	19.4	2955	2603	152
		780	33.8	26.3	3870	3391	147
		1170	34.8	40.8	5736	5163	141
		1755	36.2	63.6	8053	6873	127
		2340	37.5	87.6	10248	8595	117
BXRE-57C4001-B-74	70	450	33.2	14.9	2814	2578	188
		600	33.8	20.3	3688	3372	182
		900	34.8	31.4	5321	4789	170
		1350	36.3	49.0	7699	6984	157
		1800	37.5	67.5	9818	8864	145
BXRE-57C4001-C-74	70	585	33.2	19.4	3564	3139	183
		780	33.8	26.3	4667	4090	177
		1170	34.8	40.8	6919	6227	170
		1755	36.2	63.6	9713	8290	153
		2340	37.5	87.6	12361	10367	141

Notes for Table 3:

1. Alternate drive currents in Table 3 are provided for reference only and are not a guarantee of performance.
2. Bridgelux maintains a ± 7% tolerance on flux measurements.
3. Typical stabilized DC performance values are provided as reference only and are not a guarantee of performance.

Performance at Commonly Used Drive Currents

Table 3: Product Performance at Commonly Used Drive Currents (Continued)

Part Number	CRI	Drive Current ¹ (mA)	Typical V_f $T_c = 25^\circ\text{C}$ (V)	Typical Power $T_c = 25^\circ\text{C}$ (W)	Typical Flux ² $T_c = 25^\circ\text{C}$ (lm)	Typical DC Flux ³ $T_c = 85^\circ\text{C}$ (lm)	Typical Efficacy $T_c = 25^\circ\text{C}$ (lm/W)
BXRE-57E4001-B-74	80	450	33.2	14.9	2789	2554	187
		600	33.8	20.3	3655	3341	180
		900	34.8	31.4	5273	4746	168
		1350	36.3	49.0	7629	6920	156
		1800	37.5	67.5	9729	8783	144
BXRE-57E4001-C-74	80	585	33.2	19.4	3531	3111	182
		780	33.8	26.3	4625	4053	176
		1170	34.8	40.8	6856	6170	168
		1755	36.2	63.6	9624	8214	151
		2340	37.5	87.6	12249	10273	140
BXRE-65C4001-B-74	70	450	33.2	14.9	2865	2625	192
		600	33.8	20.3	3755	3433	185
		900	34.8	31.4	5418	4876	173
		1350	36.3	49.0	7839	7111	160
		1800	37.5	67.5	9997	9025	148
BXRE-65C4001-C-74	70	585	33.2	19.4	3628	3196	187
		780	33.8	26.3	4752	4164	180
		1170	34.8	40.8	7045	6340	173
		1755	36.2	63.6	9889	8440	155
		2340	37.5	87.6	12586	10556	144
BXRE-65E4001-B-74	80	450	33.2	14.9	2840	2601	190
		600	33.8	20.3	3722	3403	184
		900	34.8	31.4	5370	4833	171
		1350	36.3	49.0	7769	7047	159
		1800	37.5	67.5	9908	8944	147
BXRE-65E4001-C-74	80	585	33.2	19.4	3596	3168	185
		780	33.8	26.3	4710	4127	179
		1170	34.8	40.8	6982	6284	171
		1755	36.2	63.6	9801	8365	154
		2340	37.5	87.6	12473	10462	142

Notes for Table 3:

1. Alternate drive currents in Table 3 are provided for reference only and are not a guarantee of performance.
2. Bridgelux maintains a $\pm 7\%$ tolerance on flux measurements.
3. Typical stabilized DC performance values are provided as reference only and are not a guarantee of performance.

Electrical Characteristics

Table 4: Electrical Characteristics

Part Number	Drive Current (mA)	Forward Voltage Pulsed, $T_c = 25^\circ\text{C}$ (V) ^{1, 2, 3, 8}			Typical Coefficient of Forward Voltage ⁴ $\Delta V_f / \Delta T_c$ (mV/ $^\circ\text{C}$)	Typical Thermal Resistance Junction to Case ^{5,6} R_{j-c} ($^\circ\text{C}/\text{W}$)	Driver Selection Voltages ⁷ (V)	
		Minimum	Typical	Maximum			V_f Min. Hot $T_c = 105^\circ\text{C}$ (V)	V_f Max. Cold $T_c = -40^\circ\text{C}$ (V)
BXRE-xxx400x-B-7x	900	32.2	34.8	37.5	-14.2	0.15	31.1	38.4
	1800	34.7	37.5	40.3	-14.2	0.18	33.5	41.2
BXRE-xxx400x-C-7x	1170	32.2	34.8	37.5	-14.2	0.11	31.1	38.4
	2340	34.6	37.5	40.3	-14.2	0.13	33.5	41.2

Notes for Table 4:

- Parts are tested in pulsed conditions, $T_c = 25^\circ\text{C}$. Pulse width is 10ms.
- Voltage minimum and maximum are provided for reference only and are not a guarantee of performance.
- Bridgelux maintains a tester tolerance of $\pm 0.10\text{V}$ on forward voltage measurements.
- Typical coefficient of forward voltage tolerance is $\pm 0.1\text{mV}$ for nominal current.
- Thermal resistance values are based from test data of a 3000K 80 CRI product.
- Thermal resistance value was calculated using total electrical input power; optical power was not subtracted from input power. The thermal interface material used during testing is not included in the thermal resistance value.
- V_f min hot and max cold values are provided as reference only and are not guaranteed by test. These values are provided to aid in driver design and selection over the operating range of the product.
- This product has been designed and manufactured per IEC 62031:2014. This product has passed dielectric withstand voltage testing at 1120 V. The working voltage designated for the insulation is 60V d.c. The maximum allowable voltage across the array must be determined in the end product application.

Absolute Maximum Ratings

Table 5: Maximum Ratings

Parameter	Maximum Rating	
LED Junction Temperature (T_j)	125°C	
Storage Temperature	-40°C to +105°C	
Operating Case Temperature ¹ (T_c)	105°C	
Soldering Temperature ²	350°C or lower for a maximum of 10 seconds	
	BXRE-xxx400x-B-7x	BXRE-xxx400x-C-7x
Maximum Drive Current ³	1800mA	2340mA
Maximum Peak Pulsed Drive Current ⁴	2571mA	3343mA
Maximum Reverse Voltage ⁵	-60V	-60V

Notes for Table 5:

1. For IEC 62717 requirement, please consult your Bridgelux sales representative.
2. Refer to Bridgelux Application Note AN41: Handling and Assembly of Bridgelux V Series LED Arrays
3. Arrays may be driven at higher currents however lumen maintenance may be reduced.
4. Bridgelux recommends a maximum duty cycle of 10% and pulse width of 20 ms when operating LED Arrays at maximum peak pulsed current specified. Maximum peak pulsed currents indicate values where LED Arrays can be driven without catastrophic failures.
5. Light emitting diodes are not designed to be driven in reverse voltage and will not produce light under this condition. Maximum rating provided for reference only.

Performance Curves

Figure 1: V18B Drive Current vs. Voltage ($T_j = T_c = 25^\circ\text{C}$)

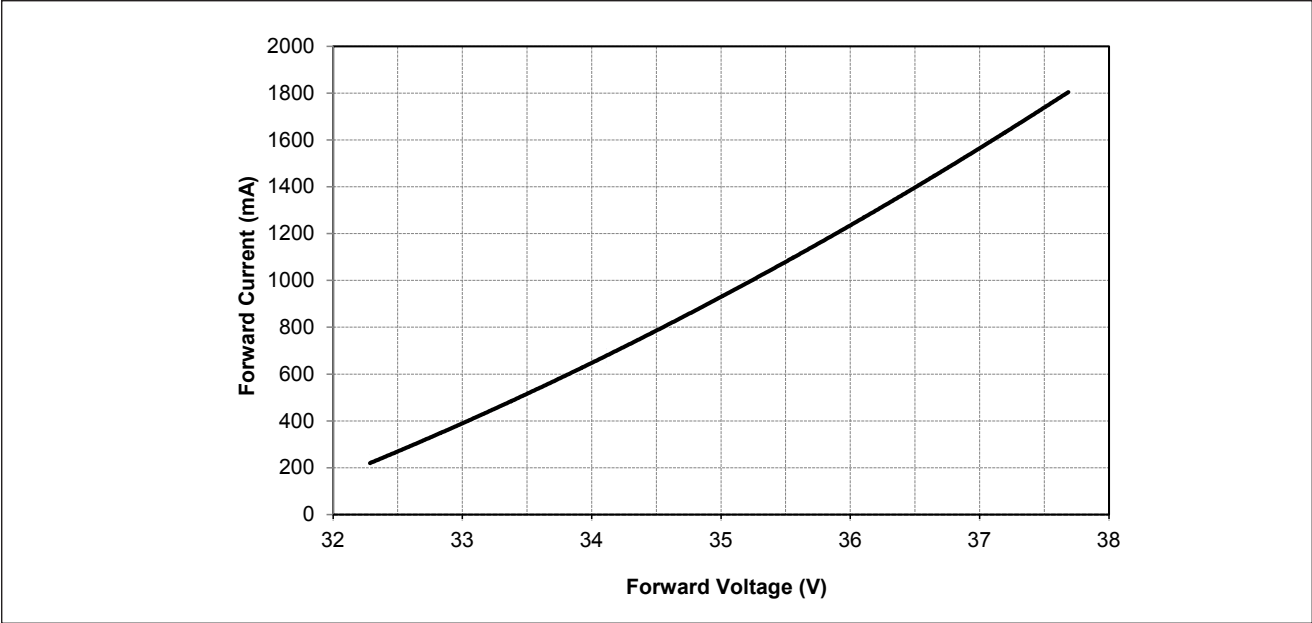
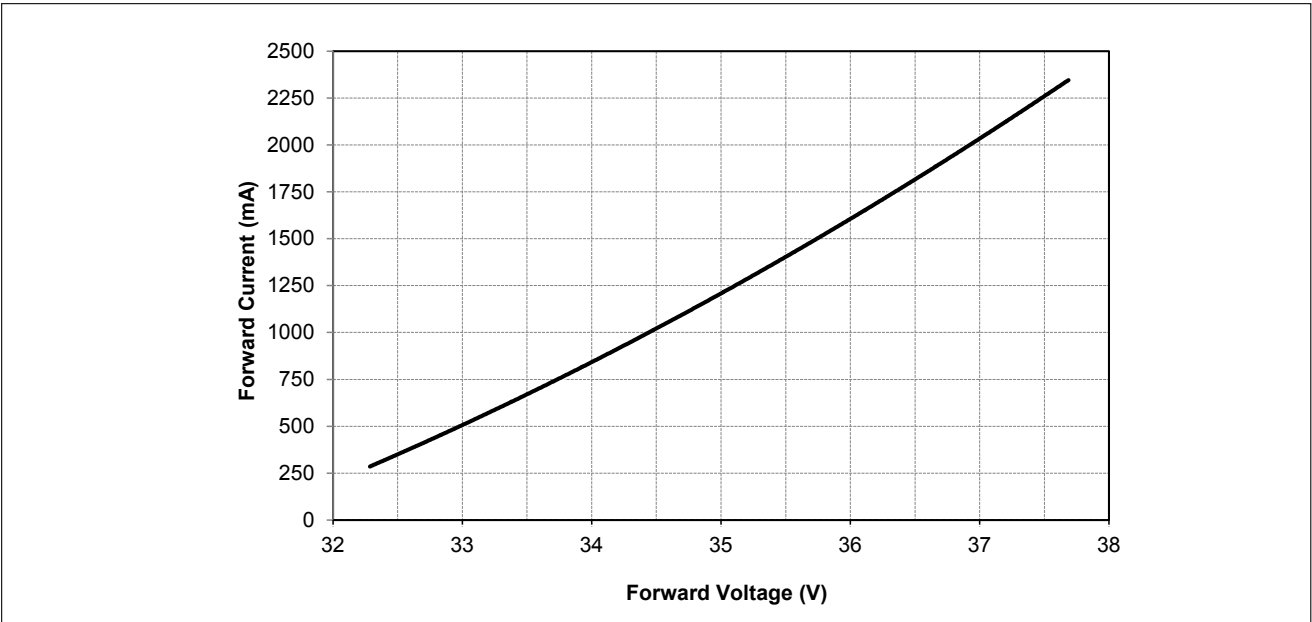

Figure 2: V18C Drive Current vs. Voltage ($T_j = T_c = 25^\circ\text{C}$)



Performance Curves

Figure 3: V18B Typical Relative Flux vs. Current ($T_j = T_c = 25^\circ\text{C}$)

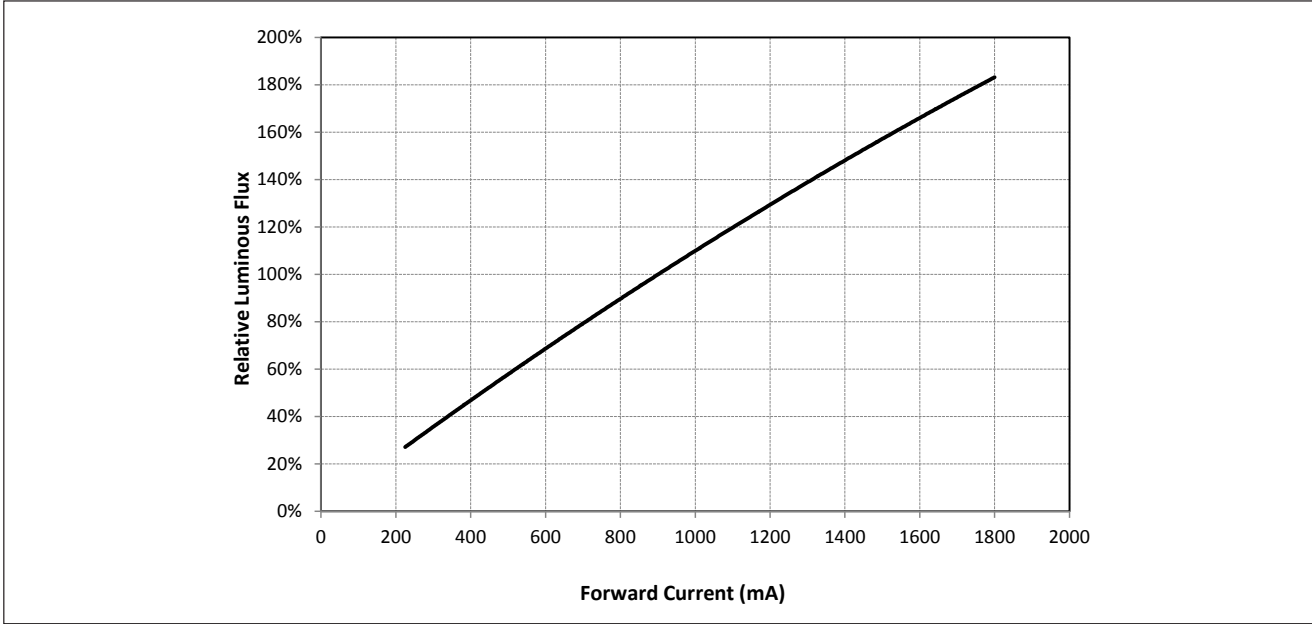
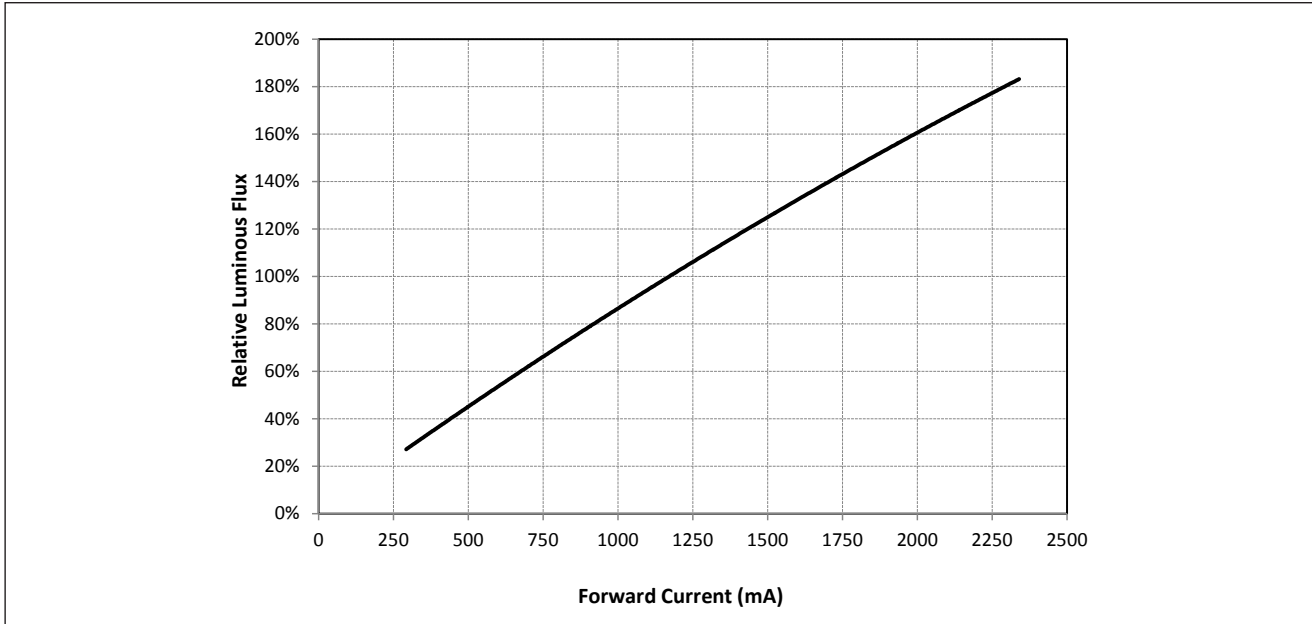

Figure 4: V18C Typical Relative Flux vs. Current ($T_j = T_c = 25^\circ\text{C}$)



Note for Figures 3 & 4:
1. Bridgelux does not recommend driving high power LEDs at low currents. Doing so may produce unpredictable results. Pulse width modulation (PWM) is recommended for dimming effects.

Performance Curves

Figure 5: Typical DC Flux vs. Case Temperature

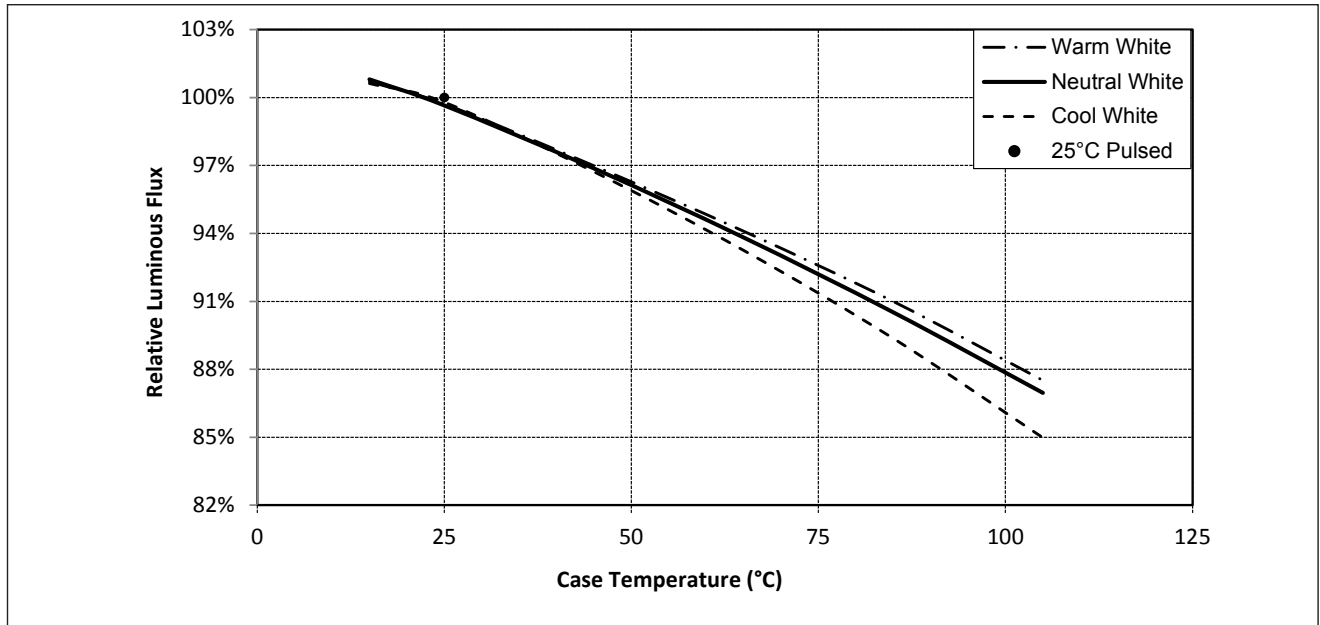
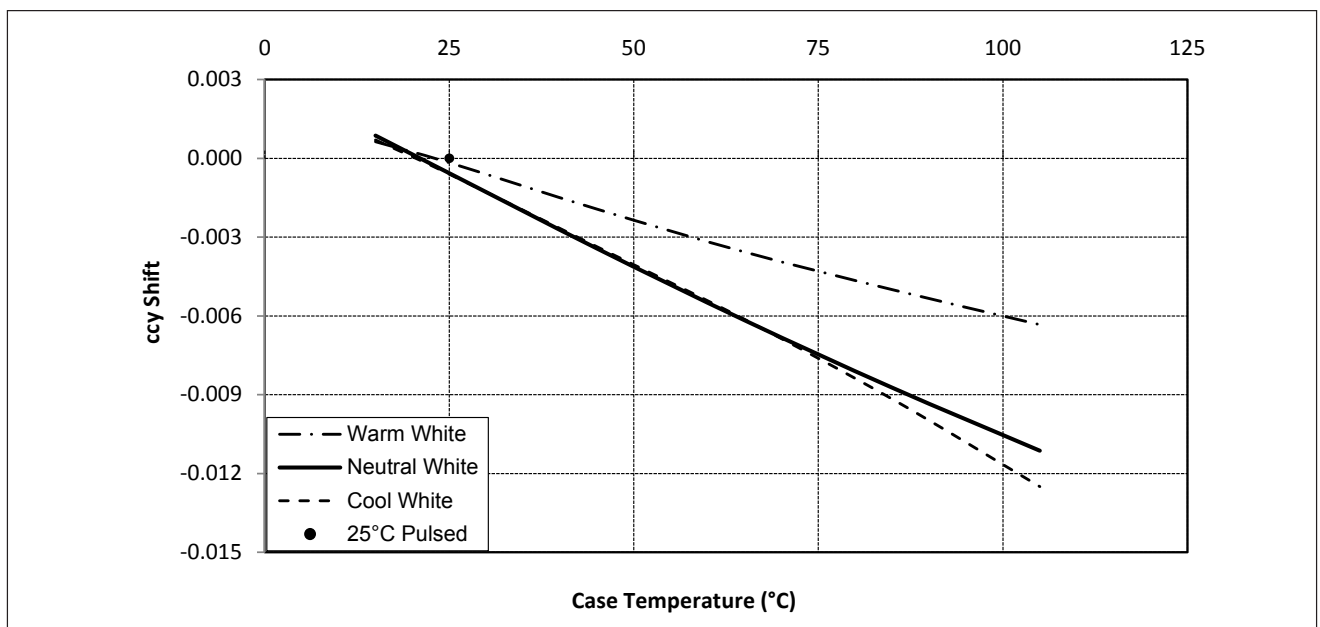

Figure 6: Typical DC ccy Shift vs. Case Temperature



Notes for Figures 5 & 6:

1. Characteristics shown for warm white based on 3000K and 80 CRI.
2. Characteristics shown for neutral white based on 4000K and 80 CRI.
3. Characteristics shown for cool white based on 5000K and 70 CRI.
4. For other color SKUs, the shift in color will vary. Please contact your Bridgelux sales representative for more information.

Performance Curves

Figure 7: Typical DC ccx Shift vs. Case Temperature

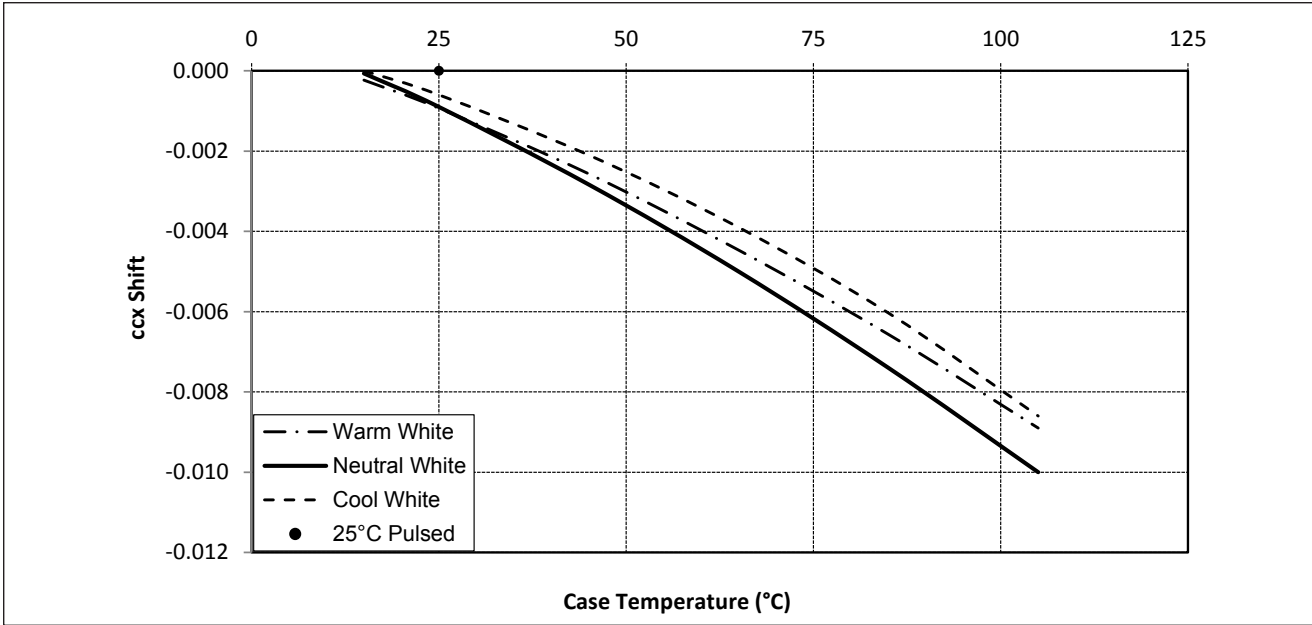

Notes for Figure 7:

1. Characteristics shown for warm white based on 3000K and 80 CRI.
2. Characteristics shown for neutral white based on 4000K and 80 CRI.
3. Characteristics shown for cool white based on 5000K and 70 CRI.
4. For other color SKUs, the shift in color will vary. Please contact your Bridgelux Sales Representative for more information.

Typical Radiation Pattern

Figure 8: Typical Spatial Radiation Pattern

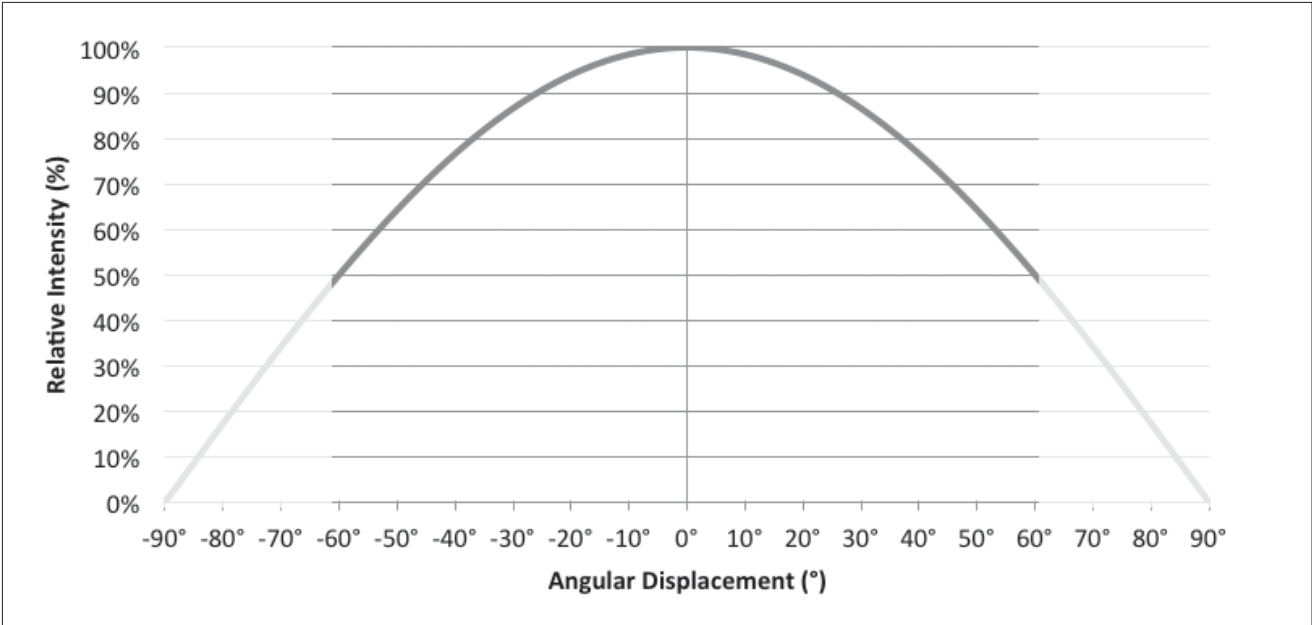

Notes for Figure 8:

- 1. Typical viewing angle is 120°.
- 2. The viewing angle is defined as the off axis angle from the centerline where intensity is 1/2 of the peak value.

Figure 9: Typical Polar Radiation Pattern

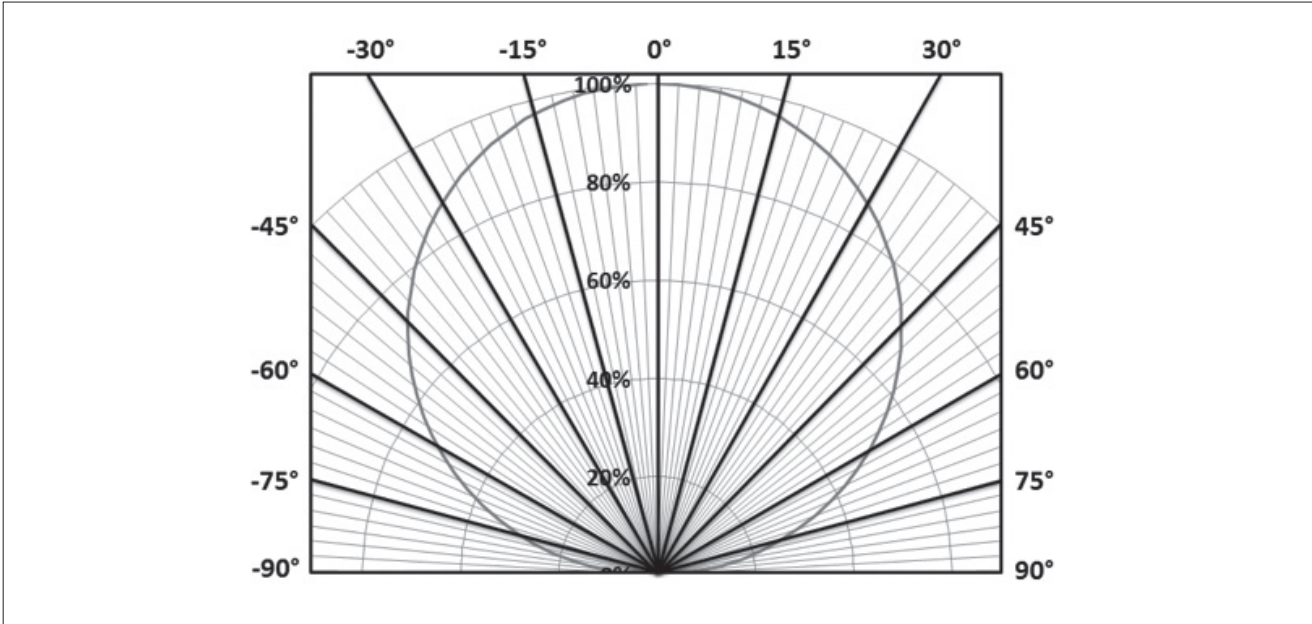

Typical Color Spectrum

Figure 10: Typical Color Spectrum

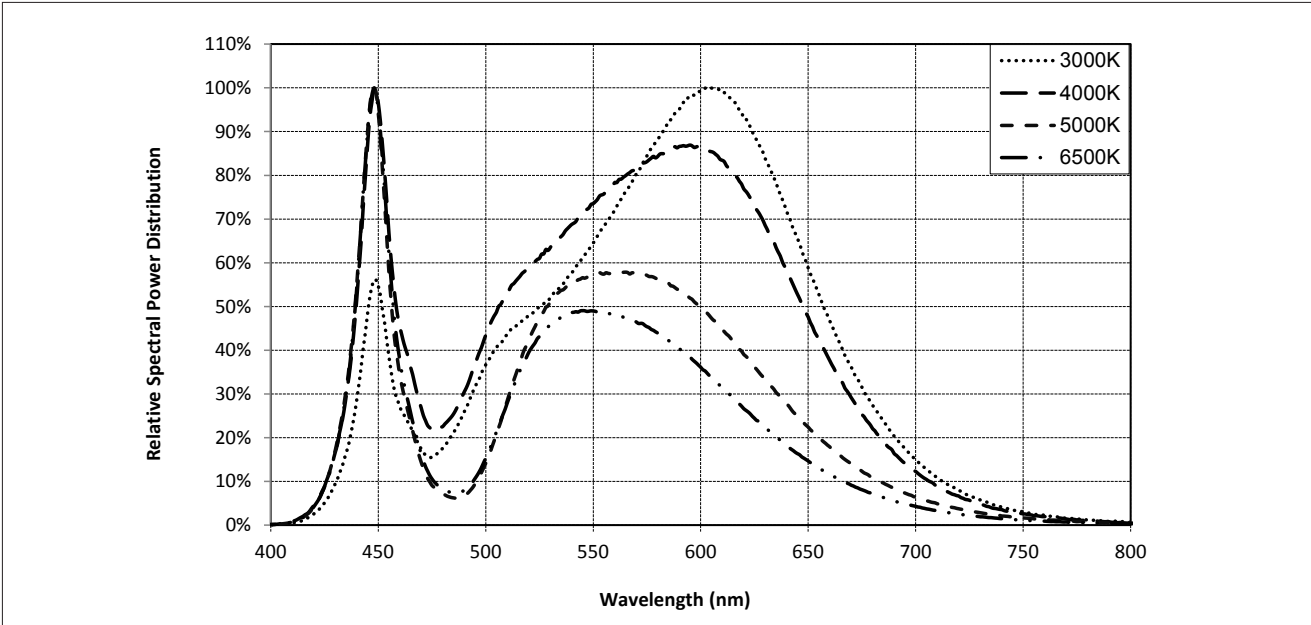

- Notes for Figure 10:
1. Color spectra measured at nominal current for $T_j = T_c = 25^\circ\text{C}$.
 2. Color spectra shown is 3000K and 80 CRI.
 3. Color spectra shown is 4000K and 80 CRI.
 4. Color spectra shown is 5000K and 70 CRI.
 4. Color spectra shown is 6500K and 70 CRI.

Mechanical Dimensions

Figure 11: V18 LED Array

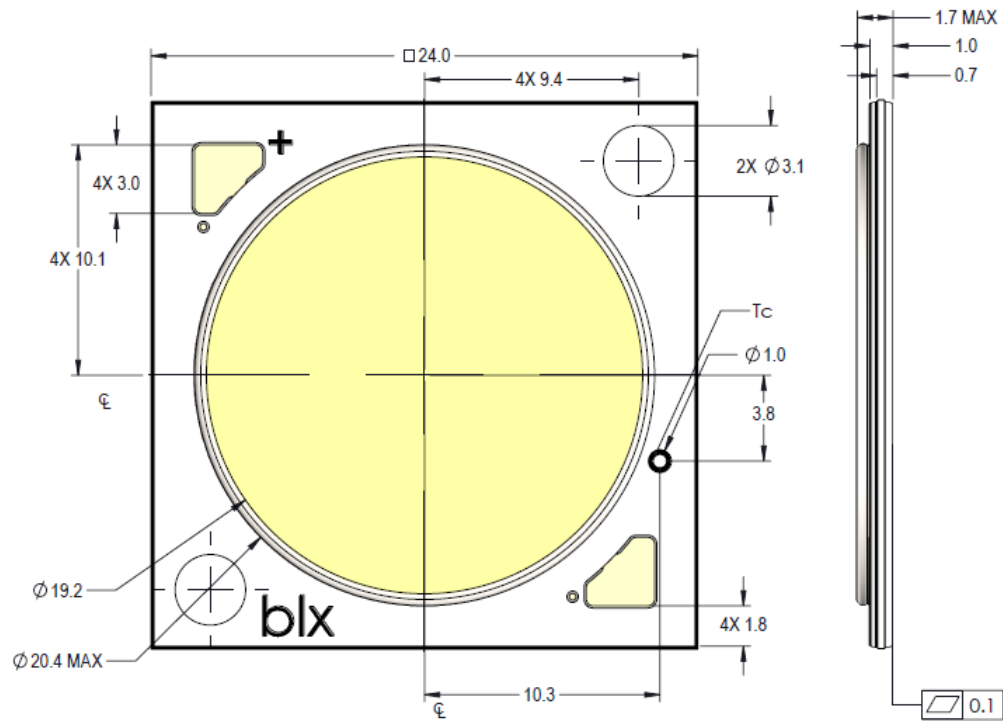

Notes for Figure 11:

1. Drawings are not to scale.
2. Drawing dimensions are in millimeters.
3. Unless otherwise specified, tolerances are $\pm 0.1\text{mm}$.
4. Mounting holes (2X) are for M2.5 screws.
5. Bridgelux recommends two tapped holes for mounting screws with $31.4 \pm 0.10\text{mm}$ center-to-center spacing.
6. Screws with flat shoulders (pan, dome, button, round, truss, mushroom) provide optimal torque control. Do NOT use flat, countersink, or raised head screws.
7. Solder pads and connector port are labeled "+" and "-" to denote positive and negative, respectively.
8. It is not necessary to provide electrical connections to both the solder pads and the connector port. Either set may be used depending on application specific design requirements.
9. Refer to Application Notes AN30 and AN31 for product handling, mounting and heat sink recommendations.
10. The optical center of the LED Array is nominally defined by the mechanical center of the array to a tolerance of $\pm 0.2\text{mm}$.
11. Bridgelux maintains a flatness of 0.10mm across the mounting surface of the array.

Color Binning Information

Figure 12: Graph of Warm and Neutral White Test Bins in xy Color Space

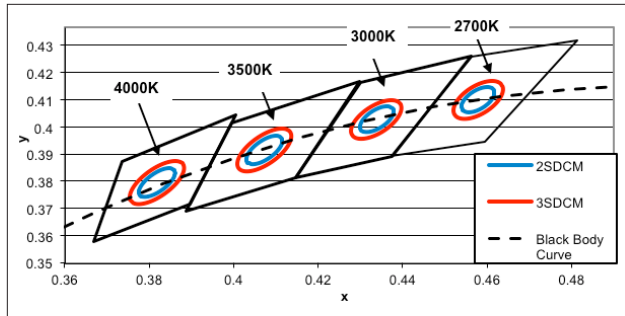

Note: Pulsed Test Conditions, $T_c = 25^\circ\text{C}$

Table 6: Warm and Neutral White xy Bin Coordinates and Associated Typical CCT

Bin Code	2700K	3000K	3500K	4000K
ANSI Bin (for reference only)	(2580K - 2870K)	(2870K - 3220K)	(3220K - 3710K)	(3710K - 4260K)
23 (3 SDCM)	(2651K - 2794K)	(2968K - 3136K)	(3369K - 3586K)	(3851K - 4130K)
22 (2 SDCM)	(2674K - 2769K)	(2995K - 3107K)	(3404K - 3548K)	(3895K - 4081K)
Center Point (x,y)	(0.4578, 0.4101)	(0.4338, 0.403)	(0.4073, 0.3917)	(0.3818, 0.3797)

Figure 13: Graph of Cool White Test Bins in xy Color Space

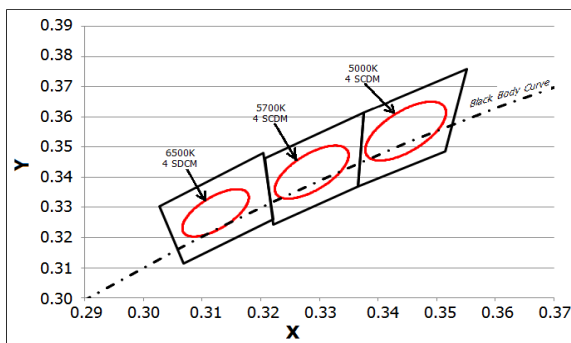

Note: Pulsed Test Conditions, $T_c = 25^\circ\text{C}$

Table 7: Cool White xy Bin Coordinates and Associated Typical CCT (product is hot targeted to $T_c = 85^\circ\text{C}$)

Bin Code	5000K	5700K	6500K
ANSI Bin (for reference only)	(4745K - 5311K)	(5312K - 6022K)	(6022K - 7042K)
4 (4 SDCM)	(4801K - 5282K)	(5829K - 5481K)	(6270K - 6765K)
Center Point (x,y)	(0.3447, 0.3553)	(0.3287, 0.3417)	(0.3123, 0.3282)

Packaging and Labeling

Figure 14: Drawing for V18 Packaging Tube

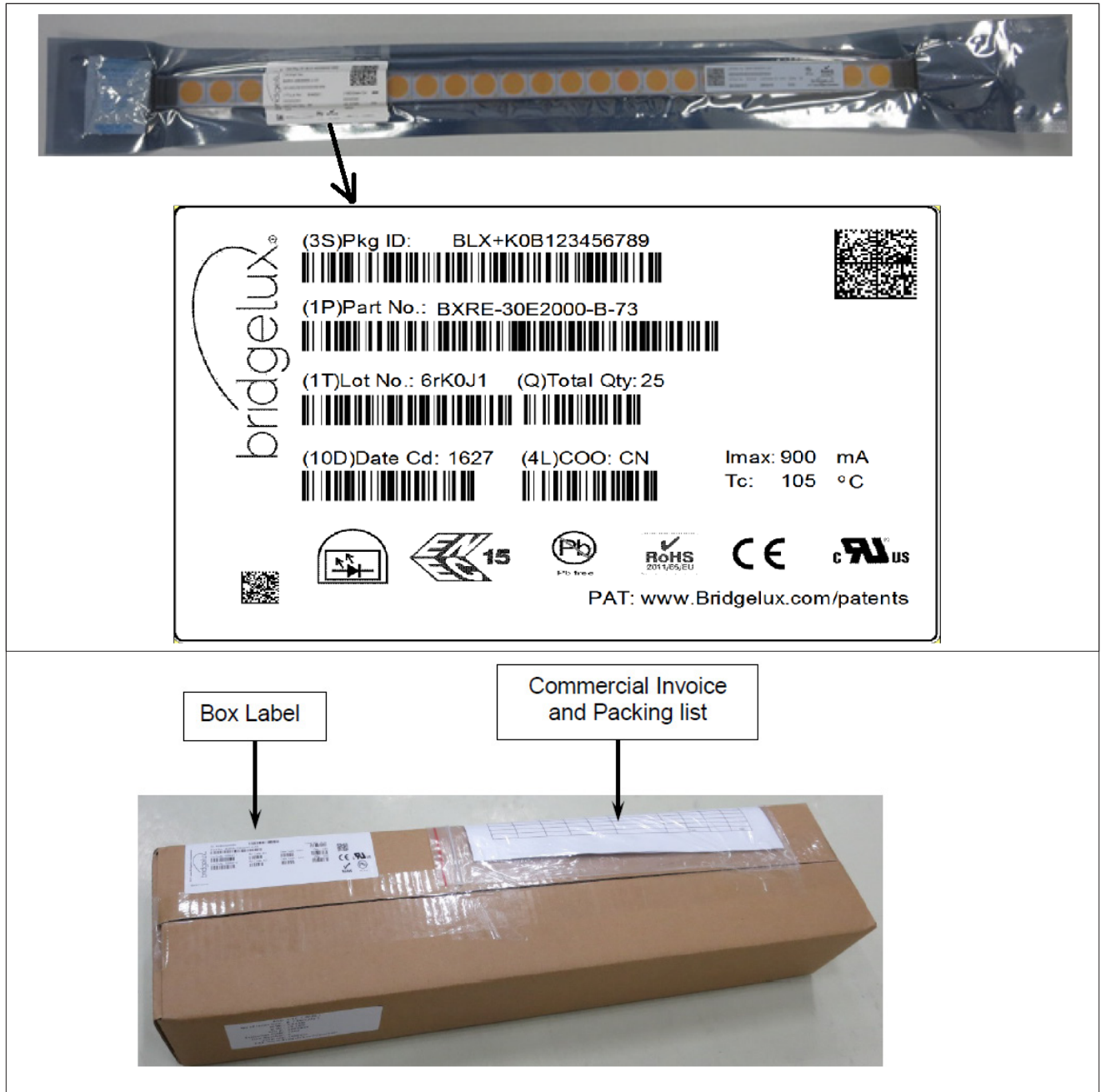

Notes for Figure 14:

1. Each tube holds 20 V18 COB arrays.
2. One tube is sealed in an anti-static bag. Four bags are placed in a shipping box. Depending on quantities ordered, a bigger shipping box, containing four boxes may be used to ship products.
3. Each bag and box is to be labeled as shown above.
4. Dimensions for each tube are 26.3 (W) x 9.5(H) x 510 (L). Dimensions for the anti-static bag are 75 (W) x 615 (L) x 3.1 (T) mm. Dimensions for the shipping box are 58.7 x 13.3 x 7.9 cm.

Packaging and Labeling

Figure 15: Gen. 7 Product Labeling

Bridgelux COB arrays have laser markings on the back side of the substrate to help with product identification. In addition to the product identification markings, Bridgelux COB arrays also contain markings for internal Bridgelux manufacturing use only. The image below shows which markings are for customer use and which ones are for Bridgelux internal use only. The Bridgelux internal manufacturing markings are subject to change without notice, however these will not impact the form, function or performance of the COB array.



Design Resources

Application Notes

Bridgelux has developed a comprehensive set of application notes and design resources to assist customers in successfully designing with the V Series product family of LED array products. For all available application notes visit www.bridgelux.com.

Optical Source Models

Optical source models and ray set files are available for all Bridgelux products. For a list of available formats, visit www.bridgelux.com.

3D CAD Models

Three dimensional CAD models depicting the product outline of all Bridgelux V Series LED arrays are available in both IGS and STEP formats. Please contact your Bridgelux sales representative for assistance.

LM80

LM80 testing is ongoing. Please contact your Bridgelux sales representative for more information.

Precautions

CAUTION: CHEMICAL EXPOSURE HAZARD

Exposure to some chemicals commonly used in luminaire manufacturing and assembly can cause damage to the LED array. Please consult Bridgelux Application Note AN31 for additional information.

CAUTION: EYE SAFETY

Eye safety classification for the use of Bridgelux V Series LED arrays is in accordance with specification IEC/TR 62778: Application of IEC 62471 for the assessment of blue light hazard to light sources and luminaires. V Series LED arrays are classified as Risk Group 2 (Moderate Risk) when operated at or below 2.5 times the nominal drive current. The Ethr value is 889.79 lux per IEC/TR 62778. Please use appropriate precautions. **Under many operating conditions the V Series LED arrays are classified as Risk Group 1, for more information please contact your Bridgelux sales representative.** It is important that employees working with LEDs are trained to use them safely.

CAUTION: RISK OF BURN

Do not touch the V Series LED array during operation. Allow the array to cool for a sufficient period of time before handling. The V Series LED array may reach elevated temperatures such that could burn skin when touched

CAUTION

CONTACT WITH LIGHT EMITTING SURFACE (LES)

Avoid any contact with the LES. Do not touch the LES of the LED array or apply stress to the LES (yellow phosphor resin area). Contact may cause damage to the LED array.

Optics and reflectors must not be mounted in contact with the LES (yellow phosphor resin area). Use the mechanical features of the LED array housing, edges and/or mounting holes to locate and secure optical devices as needed.

Disclaimers

MINOR PRODUCT CHANGE POLICY

The rigorous qualification testing on products offered by Bridgelux provides performance assurance. Slight cosmetic changes that do not affect form, fit, or function may occur as Bridgelux continues product optimization.

STANDARD TEST CONDITIONS

Unless otherwise stated, array testing is performed at the nominal drive current.

About Bridgelux: We Build Light That Transforms

At Bridgelux, we help companies, industries and people experience the power and possibility of light. Since 2002, we've designed LED solutions that are high performing, energy efficient, cost effective and easy to integrate. Our focus is on light's impact on human behavior, delivering products that create better environments, experiences and returns—both experiential and financial. And our patented technology drives new platforms for commercial and industrial luminaires.

For more information about the company, please visit

bridgelux.com

twitter.com/Bridgelux

facebook.com/Bridgelux

WeChat ID: BridgeluxInChina



101 Portola Avenue

Livermore, CA 94551

Tel (925) 583-8400

Fax (925) 583-8410

www.bridgelux.com

© 2016 Bridgelux, Inc. All rights reserved 2016. Product specifications are subject to change without notice. Bridgelux, the Bridgelux stylized logo design and Vero are registered trademarks, and Decor Series is a trademark of Bridgelux, Inc. All other trademarks are the property of their respective owners.

Bridgelux Gen 7 V18 Array Series Product Data Sheet DS102 Rev. C (07/2016)