



Specification

SPECIFICATION

Part No. : **PC27.09.0100A**

Specification No : PC-2709-09

Product Name : **TheStripe™** 850/900/1800/1900MHz GSM PCB Antenna
W/100mm 1.13 Coaxial Cable MMCX (M) R/A connector

Features : 34mm*7mm*0.8mm

Photo :



REVISION STATUS

Version	Date	Page	Revision Description	Prepared	Approved
01	Jan 02 nd 2006	All	New Product	TW Product Centre	Ronan Quinlan
02	Jan 29 th 2010	1	Product Color Change	TW Product Centre	Ronan Quinlan



1.0 Introduction

This miniaturized low profile PCB antenna is based on smart TheStripe™ antenna technology. It consists of a PCB antenna and 1.13mm coaxial cable with MMCX(M) 90 degree connector.

2.0 Antenna Performance

Communication System	AMPS	GSM	DCS	PCS
Frequency Band	800 MHz	900 MHz	1800 MHz	1900 MHz
VSWR	3.59	2.02	2.21	2.3
Return Loss	-4.96 dB	-9.48 dB	-8.46 dB	-8.06 dB
Impedance	50 Ohm			
Radiation Pattern	Omni-Directional			
Polarization	Horizontal			



3.0 Mechanical Dimensions

3.1 Dimensions and Drawing

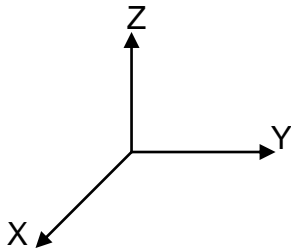

- Note :
1. The upper face of the PCB is in the Z axis
 2. Connector positioning is towards the X direction



3.2 Cable & Connector

3.2.1	RF Cable	\varnothing 1.13 Coaxial Cable L = 100 +/- 3 mm
3.2.2	RF Connector	MMCX (M) R/A



4.0 Antenna Electrical Characteristics

4.1 VSWR

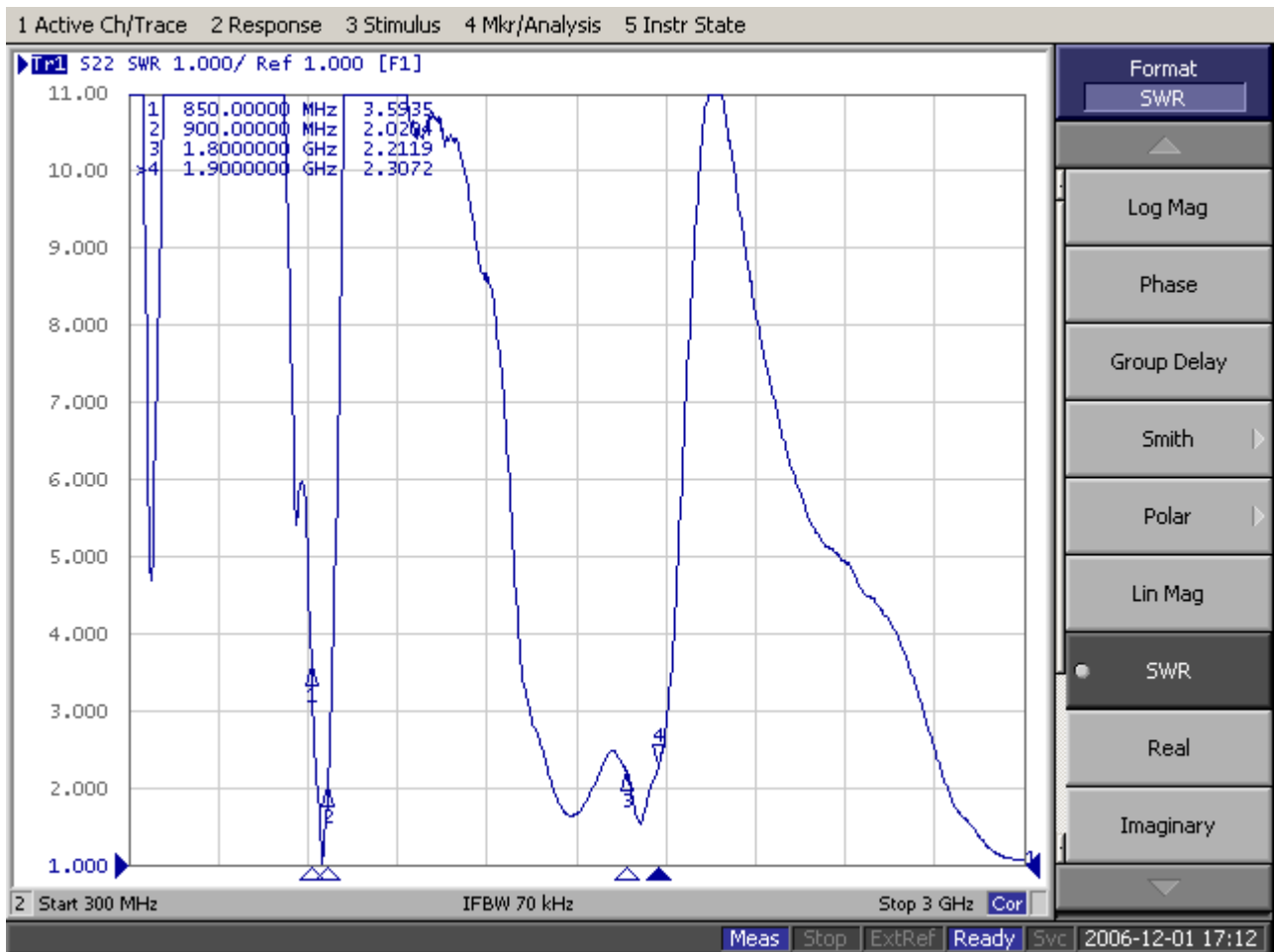



Specification

4.2 Return Loss

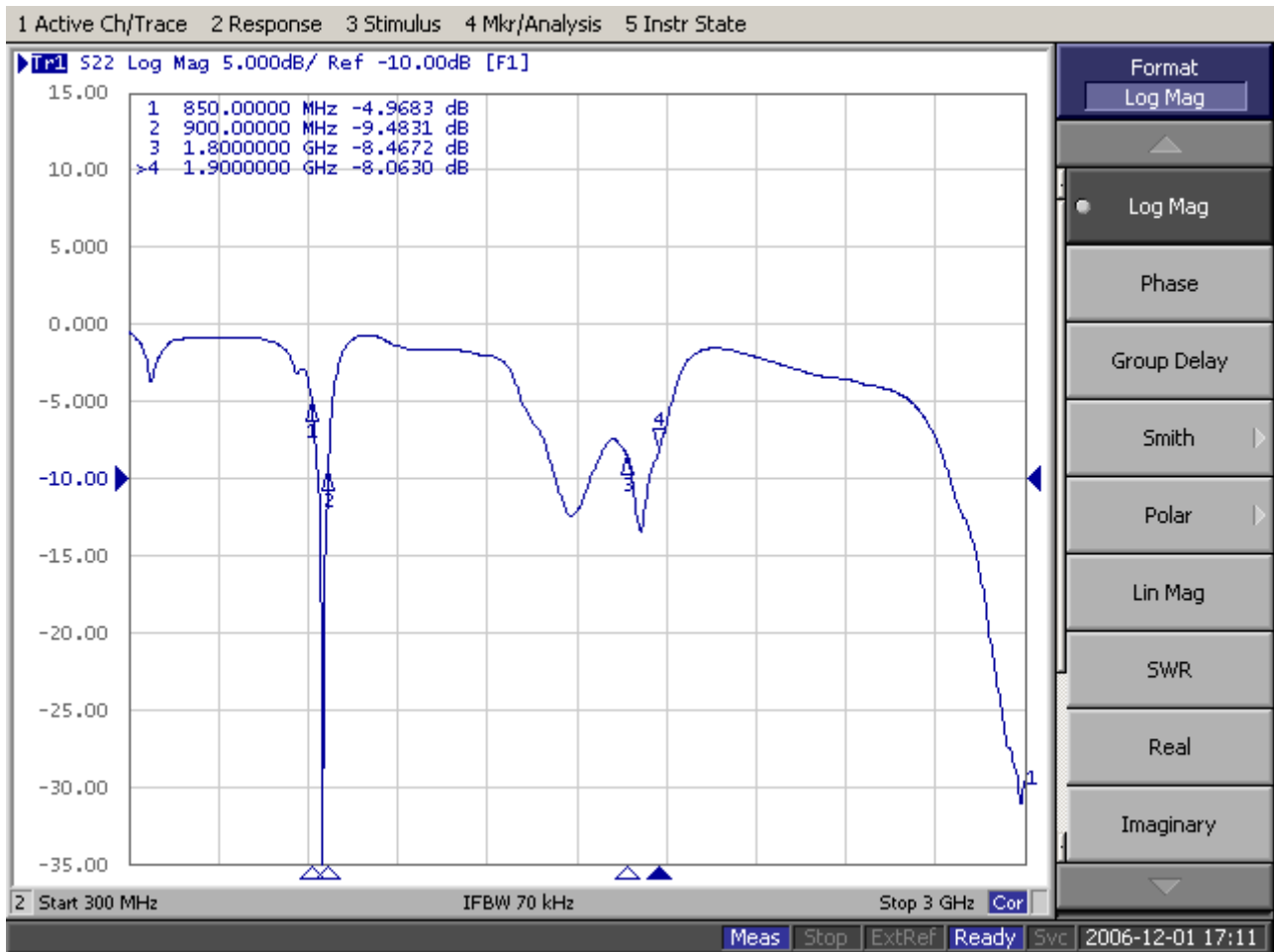



5.0 Environmental Conditions and Reliability

5.1 Environmental Conditions

5.1.1	Operation Temperature	-20°C to + 65°C
5.1.2	Storage Temperature	-30°C to + 75°C
5.1.3	Relative Humidity	40% to 95%

5.2 Reliability

Test Items	Procedure	Requirement
Thermal Shock	Starting at -40 for 30minutes and then cycled to +85 to remain 30minutes (a complete cycle). To repeat 5 complete cycles. (Refer to IEC 68-2-14 Method Na)	<ol style="list-style-type: none"> The value of return loss must be within product specifications after this test. No physical deformation should be evident.
Storage Temperature (Cold)	Samples must be put into -30°C chamber for 72 hours and samples shall be powered during test. (Refer to IEC 68-2-1 Method Aa)	<ol style="list-style-type: none"> The value of return loss must be within product specifications after this test. No physical deformation should be evident.
Storage Temperature (Dry Heat)	Samples must be put into +75°C chamber for 72 hours and samples shall be powered during test. (Refer to IEC 68-2-1 Method Ba)	<ol style="list-style-type: none"> The value of return loss must be within product specifications after this test. No physical deformation should be evident.
Operating Temperature (Cold)	Samples must be put into -20°C chamber for 2 hours and samples shall be powered during test. (Refer to IEC 68-2-1 Method Aa)	<ol style="list-style-type: none"> The value of return loss must met specification during test/after test No mechanical defects after test.
Operating Temperature (Dry Heat)	Samples must be put into +65°C chamber for 72 hours and samples shall be powered during test. (Refer to IEC 68-2-1 Method Ba)	<ol style="list-style-type: none"> The value of return loss must met specification during test/after test no mechanical defects after test.



6.0 Antenna Test Setup and Results

6.1 Equipment

Radiation Pattern Testing - Anechoic Chamber

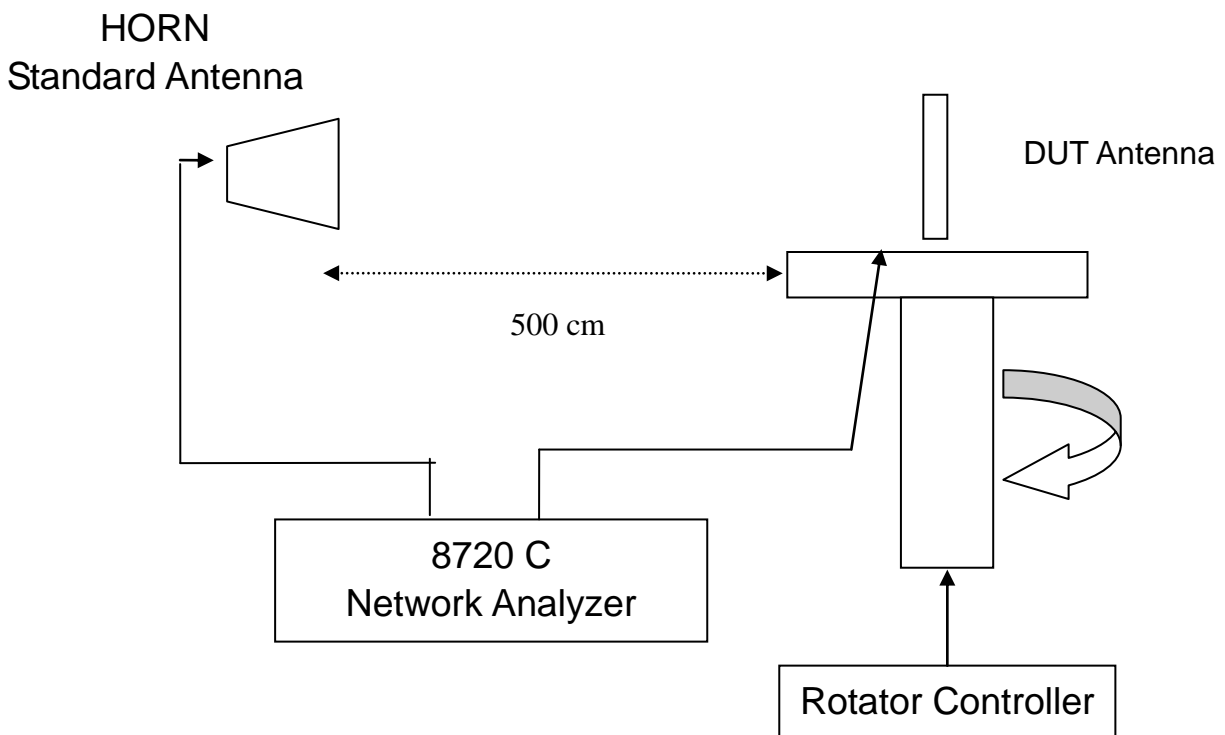



6.2 3D Radiation Pattern Testing

850 MHz

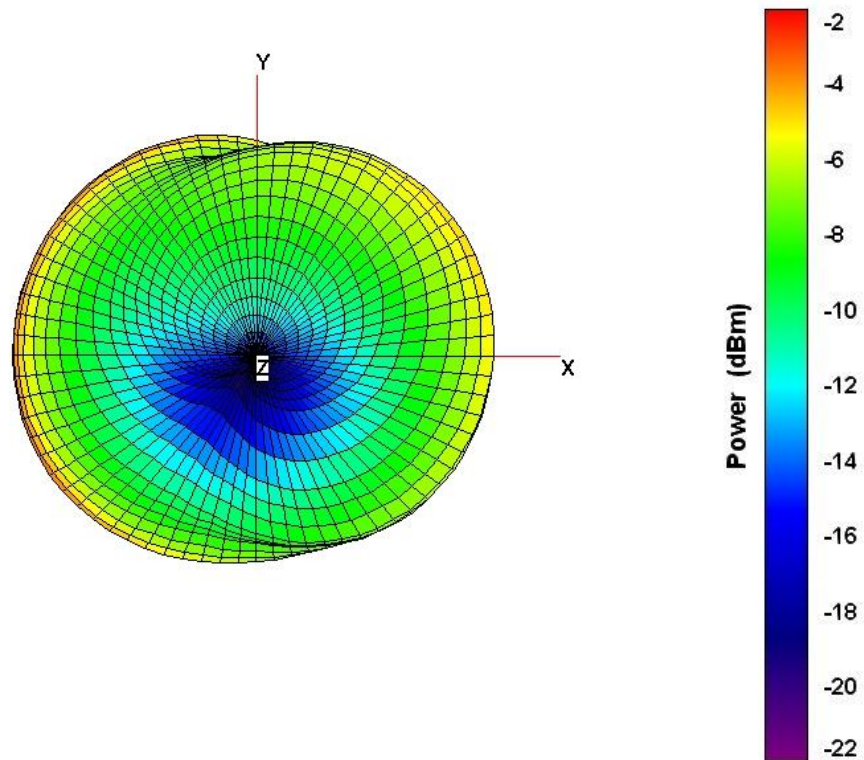



900 MHz

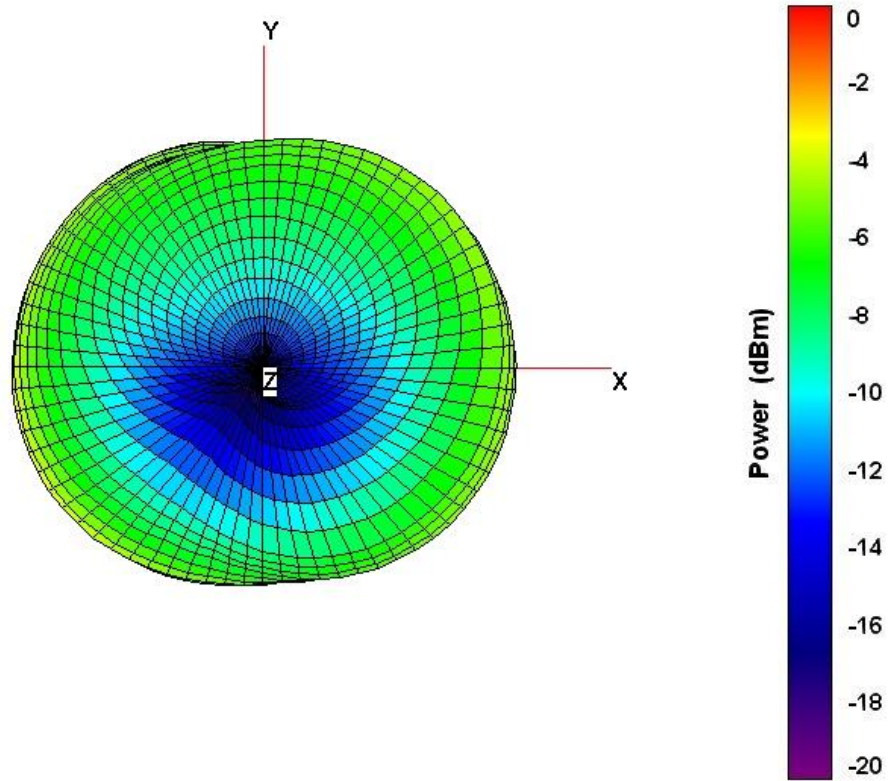

1800 MHz



Specification

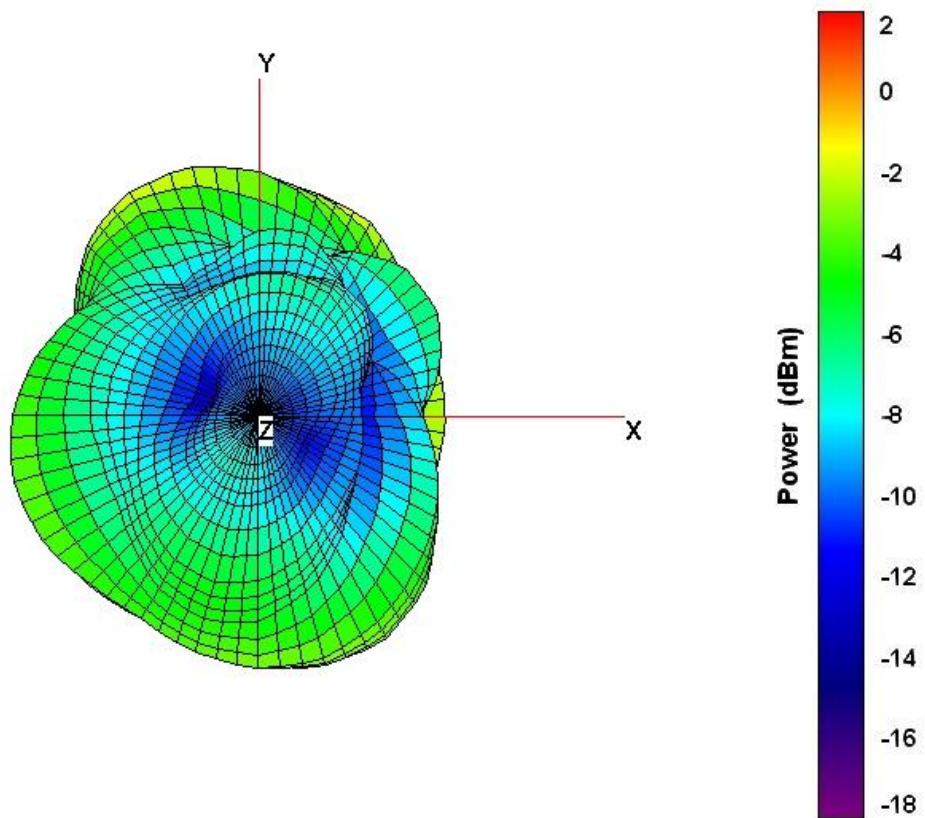
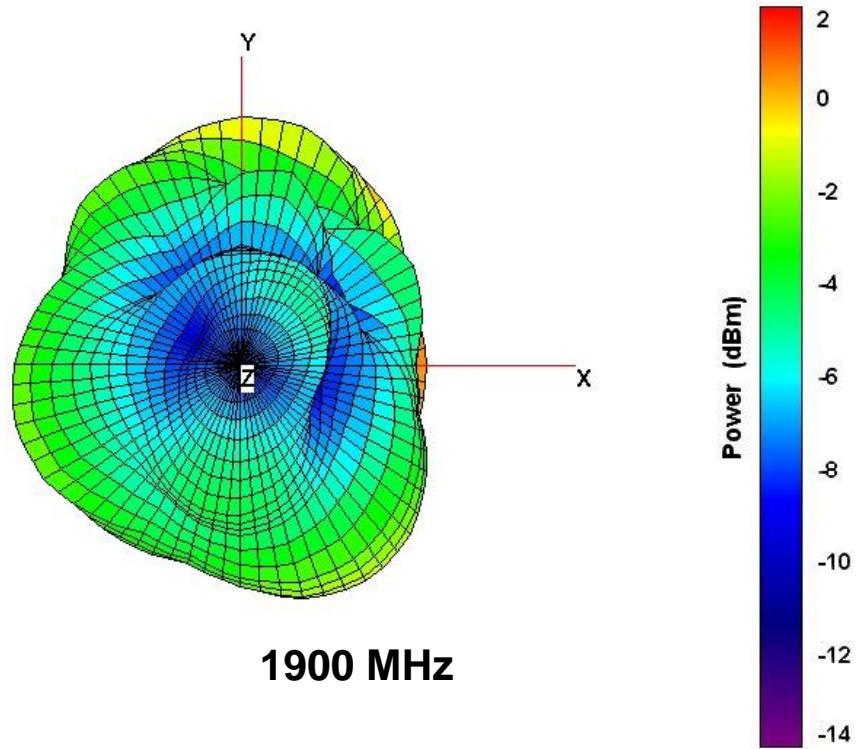



Specification

6.3 Chamber Testing - Tabular Results

Frequency	850	900	1800	1900
Note	MMCX			
Ant. Port Input Pwr. (dBm)	0	0	0	0
Tot. Rad. Pwr. (dBm)	-6.70207	-5.99557	-3.58516	-5.37679
Peak EIRP (dBm)	-2.40694	-1.57714	1.90289	0.060763
Directivity (dBi)	4.29514	4.41842	5.48805	5.43755
Efficiency (dB)	-6.70207	-5.99557	-3.58516	-5.37679
Efficiency (%)	21.3694	25.1445	43.801	28.9949
Gain (dBi)	-2.40694	-1.57714	1.90289	0.060763
NHPRP ±Pi/4 (dBm)	-7.60628	-6.98737	-4.95228	-6.71252
NHPRP ±Pi/6 (dBm)	-8.96174	-8.37139	-6.68997	-8.43839
NHPRP ±Pi/8 (dBm)	-10.17	-9.55263	-7.9014	-9.58462
Upper Hem. PRP (dBm)	-11.6509	-11.2301	-8.08553	-9.80534
Lower Hem. PRP (dBm)	-8.37684	-7.54214	-5.48811	-7.31973
NHPRP4 / TRP Ratio (dB)	-0.90421	-0.9918	-1.36712	-1.33574
NHPRP4 / TRP Ratio (%)	81.2044	79.5829	72.9942	73.5235
NHPRP6 / TRP Ratio (dB)	-2.25967	-2.37582	-3.10481	-3.0616
NHPRP6 / TRP Ratio (%)	59.4338	57.8653	48.9237	49.4128
NHPRP8 / TRP Ratio (dB)	-3.46791	-3.55706	-4.31624	-4.20784
NHPRP8 / TRP Ratio (%)	44.9996	44.0853	37.0149	37.9504
UHPRP / TRP Ratio (dB)	-4.94881	-5.2345	-4.50037	-4.42856
UHPRP / TRP Ratio (%)	31.9977	29.9606	35.4784	36.0698
LHPRP / TRP Ratio (dB)	-1.67477	-1.54657	-1.90295	-1.94294
LHPRP / TRP Ratio (%)	68.0023	70.0394	64.5216	63.9302
Front/Back Ratio (dB)	3.58199	5.22619	7.98457	8.74956
Phi BW (°)	137	132	109	92
+ Phi BW (°)	52	51	76	61
- Phi BW (°)	85	81	33	31
Theta BW (°)	53	51	18	18
+ Th. BW (°)	25	27	9	10
- Th. BW (°)	28	24	9	8
Boresight Phi (°)	210	210	0	360
Boresight Th. (°)	120	120	135	135
Maximum Power (dBm)	-2.40694	-1.57714	1.90289	0.060763
Minimum Power (dBm)	-20.7114	-19.4284	-12.8702	-17.302
Average Power (dBm)	-7.56269	-6.68836	-3.63931	-5.51374
Max/Min Ratio (dB)	18.3044	17.8513	14.7731	17.3628
Max/Avg Ratio (dB)	5.15575	5.11122	5.5422	5.5745
Min/Avg Ratio (dB)	-13.1487	-12.7401	-9.23091	-11.7883
Average Gain (dB)	-6.70207	-5.99557	-3.58516	-5.37679
E-Plane BW (°)	143	77	113	70
+ E-Plane BW (°)	108	46	92	51
- E-Plane BW (°)	35	31	21	19
H-Plane BW (°)	103	104	19	19
+ H-Plane BW (°)	70	75	10	10
- H-Plane BW (°)	33	29	9	9



Specification

7.0 Antenna Packaging

